

# VIDEO DOOR ENTRY SYSTEM



IP SYSTEM  
FOR THE BEST  
PERFORMANCE



# COMPANY PROFILE

# LEGRAND



For more than 60 years, Legrand has been supplying integrated solutions for lighting, heating, energy, network and access management in buildings.

The core business of the Group is to design, develop, and sell electrical and digital systems that are both simple and innovative, for better communication, tighter security, and improved comfort and convenience in buildings. Legrand is more than ever looking to the future. The video door entry system range is made by BTicino, a brand of the Legrand Group.

#### AN ACTIVE INTERNATIONAL PRESENCE

**Asia, Middle East and Pacific:** Australia / China / Hong-Kong / India / Indonesia / Iran / Kazakhstan / Lebanon / Malaysia / New Zealand / Philippines / Qatar / Saudi Arabia / Singapore / South Korea / Syria / Thailand / United Arab Emirates / Uzbekistan / Vietnam / **The Americas:** Brazil / Canada / Chile / Colombia / Costa Rica / Mexico / United States / Venezuela / **Europe and Africa:** Algeria / Austria / Belarus / Belgium / Bosnia-Herzegovina / Bulgaria / Croatia / Czech Republic / Denmark / Egypt / Estonia / France / Germany / Greece / Hungary / Ireland / Italy / Libya / Lithuania / Morocco / Netherlands / Poland / Portugal / Romania / Russia / Serbia and Montenegro / Senegal / Slovakia / Slovenia / South Africa / Spain / Switzerland / Tunisia / Turkey / Ukraine / United Kingdom

Active in **180** markets.

Over **90** branches.

Over **4.600** active patents.

Over **17.000** hours/year dedicated to training employees on environmental issues.

**5%** of revenue invested in r&d.

**50%** of sales generated with products added to the catalogue less than 5 years ago.

**37%** of total investments dedicated to the development of new products and solutions.

Over **170.000** products in the catalogue.

More than **38.200** employees throughout the world.

Over **4 billion** electrical devices installed throughout the world.

**Legrand**

world leader in digital and electrical infrastructures,  
of which BTicino is the leader in Italy.

**BTicino**

the global specialist in video door entry systems,  
home automation and smart home.



# IP SYSTEM FOR THE BEST PERFORMANCE

The ideal solution for large multiple-dwelling projects,  
able to guarantee high performance,  
long distances and high video signal quality.







## reddot winner 2021

The "Red Dot" is a highest design quality award. The international jury only awards this sought-after seal of approval to products of outstanding design.



Entrance panel

Video indoor unit

Guard station

**Wide range of products with flexible and scalable solutions to satisfy every building needs.**

### MAIN PERFORMANCES AND FUNCTIONALITIES

**Multichannel:** for simultaneous conversations (no busy lines);

**High definition video quality:** up to 1280 x 720;

**Technology:** IP protocol (SIP/TCP);

**Cables:** FTP and UTP (CAT5 - CAT5E - CAT6) - Fiber optic

**Configuration:** easy and quick configuration with dedicated software;

**Integration:** Onvif IP Cameras, Lift control, Alarm sensors;

**App Home + Security:** incoming calls answering and door locks activation by smartphone.

# MULTIPLE WAYS TO CALL THE APARTMENT



- 1. STANDARD CALL**  
Area-Building-Riser  
Floor-Apartment
- 2. ALPHANUMERIC CALL**  
Create codes  
with numbers and letters
- 3. ADDRESS BOOK**  
With contact list  
(touch displays only)

# MULTIPLE WAYS TO ACCESS THE BUILDING



**1. FACE RECOGNITION**

**2. FINGERPRINT**

**3. RFID CARD AND BADGE**

**4. ACCESS CODE**

**5. SMARTPHONE**





# ALWAYS AWARE WITH THE **HOME + SECURITY APP**

## THE BEST APP FOR A SAFE HOME

Alerts and notifications for incoming calls, motion and people detection, event information and door lock management with a simple and intuitive interface.



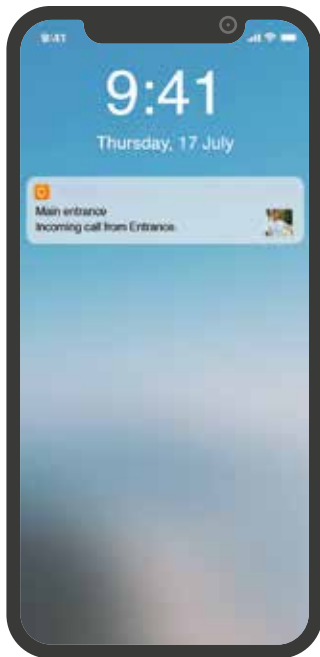

**INCOMING CALL**  
Receive notification when someone is calling



**SEE WHO'S CALLING**  
Answer the call and open the gate for the courier



**CHECK EVENTS**  
Check who called you and if they left you a message

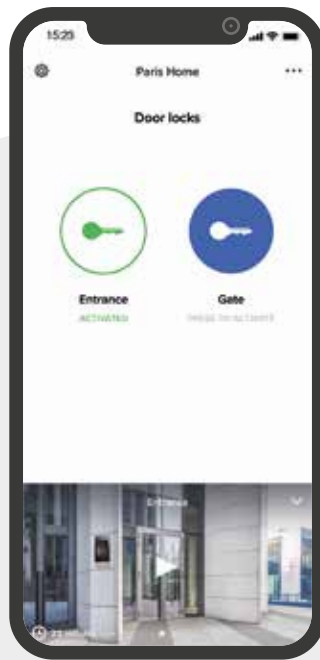

**QUICK ACTIONS**

- Activate the electrical door locks
- Call home / Intercom
- Activate the cameras
- Manage the answering machine



**Home + Security**  
The best App for a safe home.



# INTEGRATIONS

## INTEGRATE WITH ONVIF IP CAMERAS

From the Guard Station it is possible to monitor all the common area IP cameras, while from the indoor units, the resident can monitor private and common area Onvif IP cameras.



### INTEGRATE WITH LIFT CONTROL

Thanks to the access control function, visitors are taken directly to the floor of the called apartment while residents can call the lift from the indoor unit or when entering the building.



**NOTE:** integration to be performed through Lift Control interface (375010), Lift Control protocol translator and dedicated software.



10 & 7 INCHES

# PREMIUM TOUCH SCREEN INDOOR UNITS

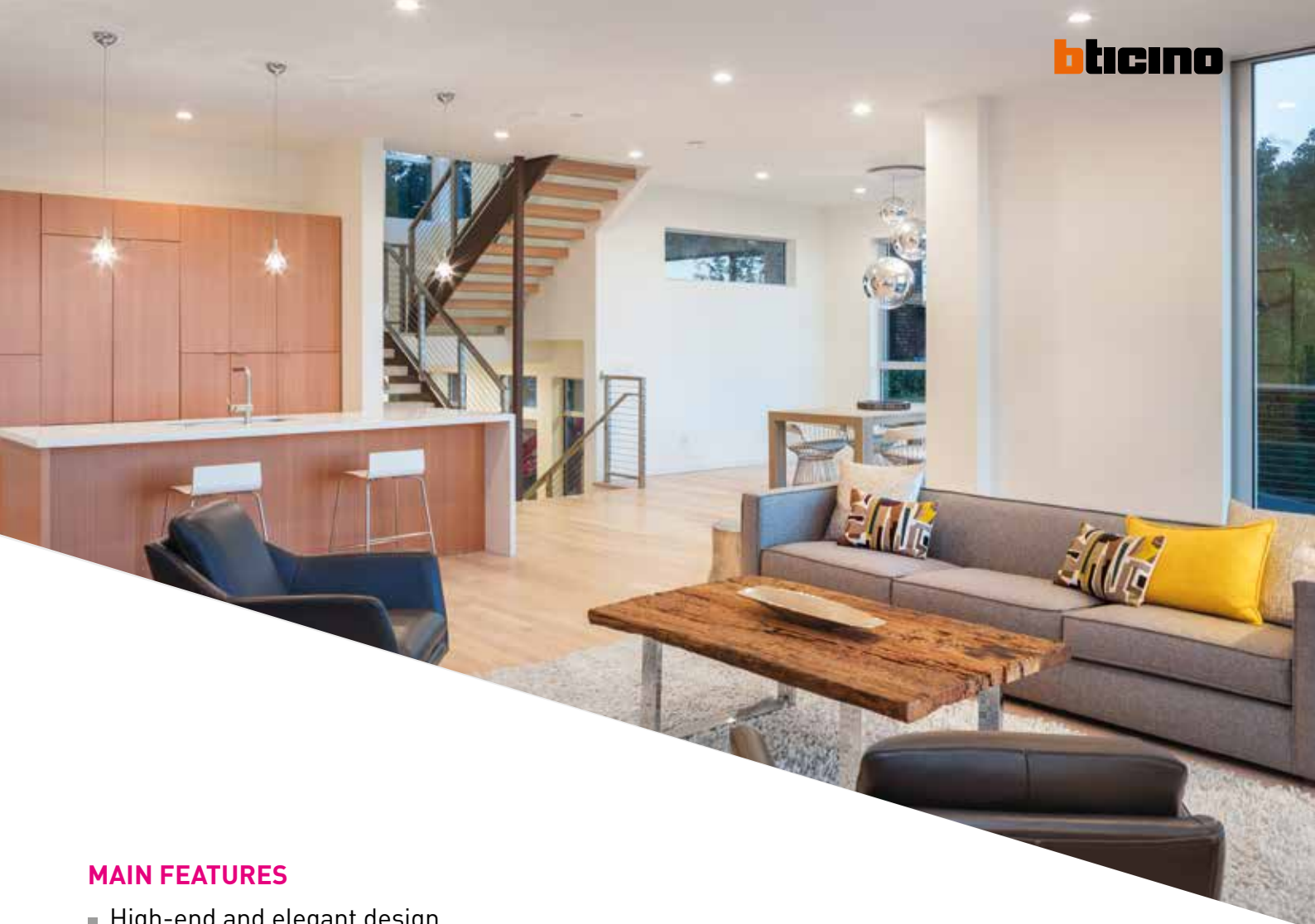

## MAIN FEATURES

- High-end and elegant design
- User friendly interface with icons
- Homepage with main functions, favorites, notifications and info
- Security functions (SOS pushbutton and possibility to connect up to 8 alarm sensors);
- Flashing LED for notifications
- Wall mounted installation



10inch touch display



7inch touch display

## ADVANCED FEATURE

- Indoor camera for video intercom call between apartments and guard station.
- **App Home + Security:** incoming calls and door locks activation by smartphone.



10inch touch display with camera



7inch touch display with camera



7 INCHES

# STANDARD TOUCH SCREEN INDOOR UNITS





**MAIN FEATURES**

- Discrete design
- User friendly interface with icons
- Homepage with main functions, favorites, notifications and info
- Security functions (possibility to connect up to 8 alarm sensors);
- Wall mounted installation.



7inch touch display Black finish



7inch touch display Champagne Gold finish

**ADVANCED FEATURE**

- **App Home + Security:** incoming calls and door locks activation by smartphone.



7inch touch display Mirror finish

# TOUCH SCREEN ENTRANCE PANELS

WITH 10 INCH TOUCH DISPLAY



## MAIN FEATURES

- Modern interaction thanks to the wide touch display
- Different calling mode
- Customizable graphic advertisement carousel and info
- Flush mounted installation

## ADVANCED FEATURE

- 3D Face recognition with liveness sensor



Entrance panel with code, card and badge reader



Entrance panel with code, card - badge - fingerprint reader and face recognition



3D Face recognition

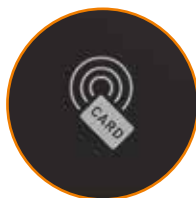

RFID Card & Badge reader



Fingerprint reader



# KEYPAD ENTRANCE PANELS

WITH 4,3 INCH DISPLAY AND KEYPAD







Entrance panel with code, card and badge reader



Entrance panel with code, card - badge - fingerprint reader and face recognition

## MAIN FEATURES

- More traditional interaction thanks to the keypad
- Different calling modes
- Flush mounted installation

## ADVANCED FEATURE

- 3D Face recognition with liveness sensor



3D Face recognition

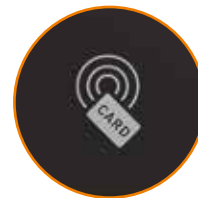

RFID Card & Badge reader



Fingerprint reader





# SMALL ENTRANCE PANELS

WITH 4,3 INCH TOUCH DISPLAY



Suitable as building and single apartment entrance panel.

## MAIN FEATURES

- Different call modes
- Direct call to guard station
- RFID card and badge reader
- Face recognition
- Code

## BUILDING



## VILLA





**DIRECT CALL**



**SINGLE APARTMENT**



**COMMON AREA**



**SUITABLE FOR INDOOR INSTALLATIONS**

Ideal as single apartment entrance panel and to access common areas in residential buildings.

**MAIN FEATURES**

- Direct call to the apartment
- Direct call to the guard station
- RFID card and badge reader

# GUARD STATION

High resolution video table-top guard station.  
10" full touch LCD display with icons menu and handset.  
It manages incoming calls: from the entrance panels with the possibility to transfer the calls to the indoor units or other guard stations. From the touch display, it is possible to see the call and alarm history, monitor alarm records and SOS calls from indoor units, monitor IP cameras installed in the common areas and entrance panel cameras.



Integrated camera for video Intercom with apartments and other guard stations (if present).

### CALL FROM THE ENTRANCE PANEL



### IP & ENTRANCE PANEL CAMERA MONITORING



### EMERGENCY AND GENERIC ALARM PROCESSING

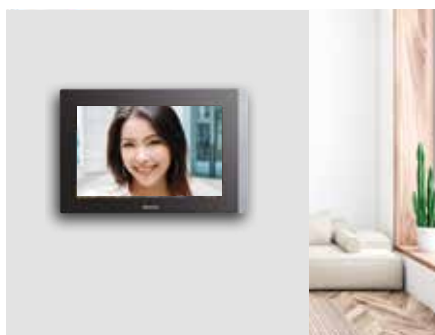
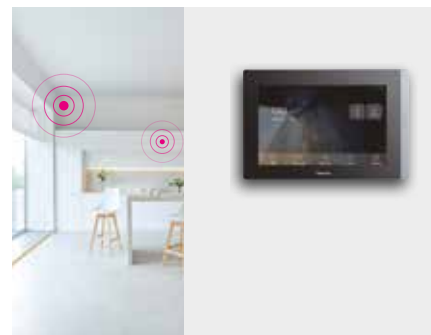

### CALL TRANSFER & INTERCOM



### COMMUNICATION & SYSTEM MANAGEMENT WITH MULTIPLE GUARD STATIONS



### USER FRIENDLY INTERFACE

## ACCESSORIES

**Power supply** 100-240 V with metal box; can be operate as an auxiliary power supply. Protected against short circuits: in case of DC output short circuit, the device will switch to protected mode. Wall-mounted installation.



Power supply

**PoE (Power over Ethernet) switch** with 10 / 100 Mbps, 8 PoE ports and 1 non-POE port uplink, and 24 V-100 W power supply. The PoE port is used for network communication and as power supply. DIN mounted installation (total of 14 DIN modules).



DIN PoE switch

### Server DES (Door Entry System) with configuration software

Must be installed in the building under the VLAN Network of the DES IP System to create, configure and update the entire installation.

### USB Key for face registration

To be inserted on DES Server to enable face registration and to provide access mode for face recognition.



Server DES

## CONFIGURATION BY SOFTWARE

Dedicated software for system configuration, which allows to create the topology of the installation, set devices parameters and easily associate all devices with a scan tool, making the installation process error-proof.



**SETUP of the COMMUNITY**  
network and general information

**SYSTEM TOPOLOGY CREATION** and device association

**SETUP of ALL PARAMETERS** to customize the installation

Additionally, diagnostics, maintenance and updates can be performed using the web pages, connecting a normal PC to the site server DES.

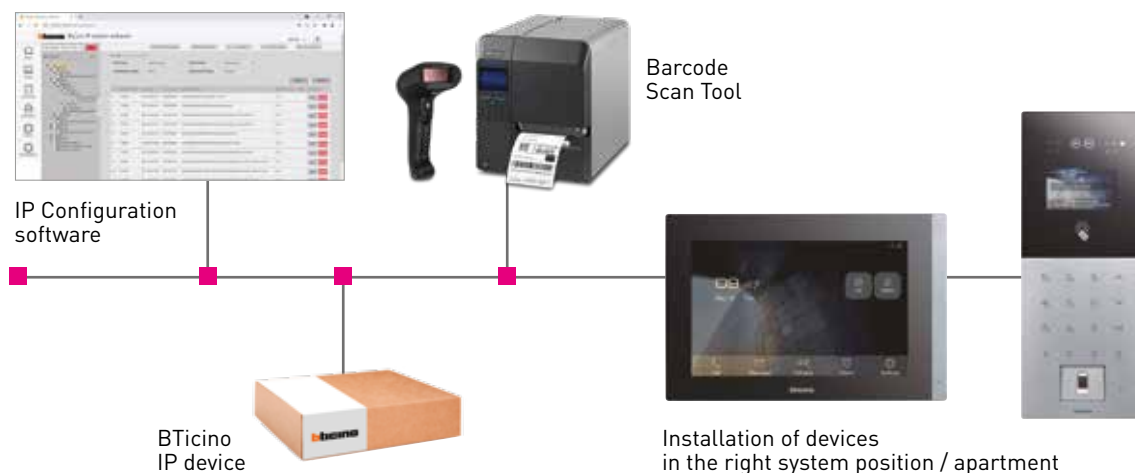

The label on the devices allows to associate them in the topology using a scan tool in a very easy and quick way. The system will then print a label, with all the position information, to be attached to the packaging. This will guarantee error-proof installation.



## DAILY MANAGEMENT

Using a normal computer, the Guard Station operator can open the software (installed on the site server), through web pages and registers update and modify residents' information and other details, including fingerprints, faces, badges and cards. It is also possible to send messages to indoor units, and change and update advertising carousel and screensavers on the entrance panels.



Registration, modification and update of the **RESIDENT'S INFO**

**ALARMS**  
Management & history

Sending **MESSAGES & INFO** to the apartments

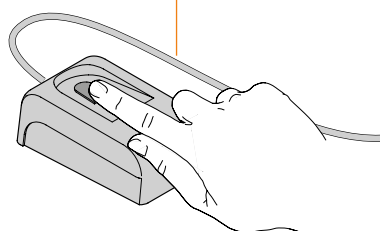

Fingerprint reader for programming

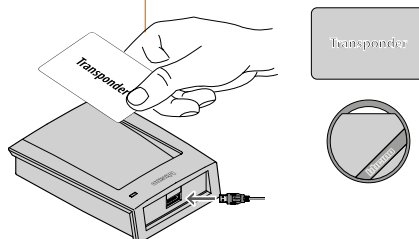

Badge reader for programming

# THE MAIN DEVICES

<b>ENTRANCE PANELS</b>	10inch TOUCH DISPLAY	4.3inch DISPLAY WITH KEYPAD	SMALL ENTRANCE PANELS
------------------------	-------------------------	--------------------------------	--------------------------



374000



374002



374001



374003



374004



374005

Colour video	•	•	•	•	•	•
Finishes / Colours	Grey	Grey	Grey	Grey	Grey	Grey
Flush mounted installation	With accessory BT-375007	With accessory BT-375007	With accessory BT-375006	With accessory BT-375006	With accessory BT-375008	With accessory BT-375009
Capacitive button call			•	•	•	
Touch display	•	•				•
Keypad			•	•		
Direct call to apartment	•	•			•	•
3D Face recognition	•		•			•
Fingerprint reader	•		•			
RFID Badge reader	•	•	•	•	•	•
Protection index	IP54	IP54	IP54	IP54	IP54	IP54
Protection index against mechanical impact	IK07	IK07	IK07	IK07	IK07	IK07

## ENTRANCE PANELS - CATALOGUE



374000



374002



374001



374003



374004



374005

Item	VIDEO ENTRANCE PANELS	Item	VIDEO ENTRANCE PANELS
374000	<p><b>Video entrance panel with 10" touch display, double face recognition camera, fingerprint reader and badge reader for access control functions.</b></p> <p>From the touch display, it is possible to make calls to the apartments and the guard station and enter the access code to release the lock. Configuration of different calling modes:</p> <ul style="list-style-type: none"> <li>- Apartment code (Area - Building - Riser - Floor - Apartment)</li> <li>- Numeric or alphanumeric codes for residents</li> <li>- Address book with contact list</li> </ul> <p>Enter the settings menu with a specific code for maintenance and for managing the settings (e.g. backlight brightness, ring volume, speaker volume, touch volume, screensaver time). Possibility to upload customized screensavers and advertisements using the configuration software.</p> <p>The entrance panel can be PoE (power over Ethernet) powered, or directly powered using power supply 375005. <b>Flush mounted installation using the dedicated box (A)-375007.</b></p>	374003	<p><b>Video entrance panel with 4.3" display, keypad with numbers and letters (A-I) and badge reader for access control functions.</b></p> <p>Using the keypad, it is possible to make calls to the apartments and the guard station and enter the access code to release the lock. Configuration of different calling modes:</p> <ul style="list-style-type: none"> <li>- Apartment code (Area - Building - Riser - Floor - Apartment)</li> <li>- Resident's alphanumeric code</li> </ul> <p>Enter the settings menu with a specific code for maintenance and for managing the settings (e.g. backlight brightness, ring volume, speaker volume, touch volume, screen saver time). Possibility to upload customized screensavers and advertisements using the configuration software.</p> <p>The entrance panel can be PoE (power over Ethernet) powered, or directly powered using power supply 375005. <b>Flush mounted installation using the dedicated box (B)-375006.</b></p>
374002	<p><b>Video entrance panel with 10" touch display and badge reader for access control functions.</b></p> <p>From the touch display, it is possible to make calls to the apartments and the guard station and enter the access code to release the lock. Configuration of different calling modes:</p> <ul style="list-style-type: none"> <li>- Apartment code (Area - Building - Riser - Floor - Apartment)</li> <li>- Numeric or alphanumeric codes for residents</li> <li>- Address book with contact list</li> </ul> <p>Enter the settings menu with a specific code for maintenance and for managing the settings (e.g. backlight brightness, ring volume, speaker volume, touch volume, screensaver time). Possibility to upload customized screensavers and advertisements using the configuration software.</p> <p>The entrance panel can be PoE (power over Ethernet) powered, or directly powered using power supply 375005. <b>Flush mounted installation using the dedicated box (A)-375007.</b></p>	374004	<p><b>Small video entrance panel for indoor installation with badge reader and key for indoor unit and guard station calls.</b></p> <p>The small video entrance panel can be PoE (power over Ethernet) powered, or directly powered using power supply 375005. <b>Flush mounted installation using the dedicated box (C)-375008.</b></p>
374001	<p><b>Video entrance panel with 4.3" display, keypad with numbers and letters (A-I), double face recognition camera, fingerprint reader and badge reader for access control functions.</b> Using the keypad, it is possible to make calls to the apartments and the guard station and enter the access code to release the lock.</p> <p>Configuration of different calling modes:</p> <ul style="list-style-type: none"> <li>- Apartment code (Area - Building - Riser - Floor - Apartment)</li> <li>- Numeric or alphanumeric codes for residents</li> </ul> <p>Enter the settings menu with a specific code for maintenance and for managing the settings (e.g. backlight brightness, ring volume, speaker volume, button volume, screensaver time). Possibility to upload customized screensavers using the configuration software. The entrance panel can be PoE (power over Ethernet) powered, or directly powered using power supply 375005. <b>Flush mounted installation using the dedicated box (B)-375006.</b></p>	374005	<p><b>Small video entrance panel with 4.3" vertical touch display, face recognition and badge reader for access control functions.</b></p> <p>From the touch display, it is possible to make calls to the apartments and the guard station and enter the access code to release the lock. Configuration of different calling modes:</p> <ul style="list-style-type: none"> <li>- Apartment code (Area - Building - Riser - Floor - Apartment)</li> <li>- Numeric or alphanumeric codes for residents</li> <li>- Address book with contact list</li> </ul> <p>Settings menu for maintenance and for managing settings (e.g. backlight brightness, ring volume, speaker volume, touch volume, screensaver time). Possibility to upload customized screensavers using the configuration software.</p> <p>This device can be PoE (power over Ethernet) powered, or directly powered using power supply 375005. <b>Flush mounted installation using the dedicated box (D)-375009.</b></p>

(A) - (B) - (C) - (D) - Correspondence with the specific flush-mounted box  
- see accessories page.

# THE MAIN DEVICES

<b>PREMIUM INDOOR UNITS</b>	<b>10inch TOUCH DISPLAY</b>	<b>7inch TOUCH DISPLAY</b>
-------------------------------------	---------------------------------	--------------------------------



373001



373003



373002



373004

Touch screen colour video	•	•	•	•
Handsfree	•	•	•	•
Finishes / Colours	Grey	Grey	Grey	Grey
Display	LCD 10inch	LCD 10inch	LCD 7inch	LCD 7inch
Indoor camera	•		•	
Answering machine	•	•	•	•
Alarm management	•	•	•	•
SOS function	•	•	•	•
Door lock release	•	•	•	•
Entrance panel camera activation	•	•	•	•
Intercom	•	•	•	•
Integration with Home+Securityapp	•	•	•	•
Audio messages	•	•	•	•
Type of installation	Wall mounted	Wall mounted	Wall mounted	Wall mounted

**STANDARD  
INDOOR  
UNITS**

 7inch  
TOUCH DISPLAY

373005



373006



373007

Touch screen colour video	•	•	•
Handsfree	•	•	•
Finishes / Colours	Black	Champagne Gold	Mirror
Display	LCD 7inch	LCD 7inch	LCD 7inch
Indoor camera			
Answering machine	•	•	•
Alarm management	•	•	•
SOS function			
Door lock release	•	•	•
Entrance panel camera activation	•	•	•
Intercom	•	•	•
Integration with Home + Security app	•	•	•
Audio messages	•	•	•
Type of installation	Wall mounted	Wall mounted	Wall mounted



## PREMIUM INDOOR UNITS - CATALOGUE



373001



373002



373003



373004

Item	VIDEO INDOOR UNIT
<b>373001</b>	<p><b>10" touch display premium indoor unit with internal camera and SOS pushbutton.</b></p> <p>From the touch display, it is possible to answer the call, open the lock, call the other apartments and the guard station, view call and alarm logs, leave audio messages, receive messages from the guard station, adjust the settings (e.g. brightness, screensaver, backgrounds and ringtone) and view date/time information. Alarm management can be easily integrated thanks to 8 pre-arranged dedicated contacts. The integration with the Onvif IP cameras allows to view the IP cameras of the apartment and the common areas from the indoor unit. The specific integration also allows control of the lift. It is possible to associate the video indoor unit to the Home + Security App (available for Android and iOS). The App allows to use functions such as: receiving calls, door lock release, display of the event timeline and activation of the entrance panel. With the Home + Security App, it is also possible to manage the products of the Netatmo Security range (outdoor and indoor cameras, door and window sensors, indoor siren, smoke detector). This allows you to quickly and easily create a Smart security system. The indoor unit can be PoE (power over Ethernet) powered, or directly powered using power supply 375005. Wall mounted using the supplied bracket.</p>
<b>373002</b>	<p><b>7" touch display premium indoor unit with internal camera and SOS pushbutton.</b></p> <p>From the touch display, it is possible to answer the call, open the lock, call the other apartments and the guard station, view call and alarm logs, leave audio messages, receive messages from the guard station, adjust the settings (e.g. brightness, screensaver, backgrounds and ringtone) and view date/time information. Alarm management can be easily integrated thanks to 8 pre-arranged dedicated contacts. The integration with the Onvif IP cameras allows to view the IP cameras of the apartment and the common areas from the indoor unit. The specific integration also allows control of the lift. It is possible to associate the video indoor unit to the Home + Security App (available for Android and iOS). The App allows to use functions such as: receiving calls, door lock release, display of the event timeline and activation of the entrance panel. With the Home + Security App, it is also possible to manage the products of the Netatmo Security range (outdoor and indoor cameras, door and window sensors, indoor siren, smoke detector). This allows you to quickly and easily create a Smart security system. The indoor unit can be PoE (power over Ethernet) powered, or directly powered using power supply 375005. Wall mounted using the supplied bracket.</p>

Item	VIDEO INDOOR UNIT
<b>373003</b>	<p><b>10" touch display premium indoor unit with SOS pushbutton.</b></p> <p>From the touch display, it is possible to answer the call, open the lock, call the other apartments and the guard station, view call and alarm logs, leave audio messages, receive messages from the guard station, adjust the settings (e.g. brightness, screensaver, backgrounds and ringtone) and view date/time information. Alarm management can be easily integrated thanks to 8 pre-arranged dedicated contacts. The integration with the Onvif IP cameras allows to view the IP cameras of the apartment and the common areas from the indoor unit. The specific integration also allows control of the lift. It is possible to associate the video indoor unit to the Home + Security App (available for Android and iOS). The App allows to use functions such as: receiving calls, door lock release, display of the event timeline and activation of the entrance panel. With the Home + Security App, it is also possible to manage the products of the Netatmo Security range (outdoor and indoor cameras, door and window sensors, indoor siren, smoke detector). This allows you to quickly and easily create a Smart security system. The indoor unit can be PoE (power over Ethernet) powered, or directly powered using power supply 375005. Wall mounted using the supplied bracket.</p>
<b>373004</b>	<p><b>7" touch display premium indoor unit with SOS pushbutton.</b></p> <p>From the touch display, it is possible to answer the call, open the lock, call the other apartments and the guard station, view call and alarm logs, leave audio messages, receive messages from the guard station, adjust the settings (e.g. brightness, screensaver, backgrounds and ringtone) and view date/time information. Alarm management can be easily integrated thanks to 8 pre-arranged dedicated contacts. The integration with the Onvif IP cameras allows to view the IP cameras of the apartment and the common areas from the indoor unit. The specific integration also allows control of the lift. It is possible to associate the video indoor unit to the Home + Security App (available for Android and iOS). The App allows to use functions such as: receiving calls, door lock release, display of the event timeline and activation of the entrance panel. With the Home + Security App, it is also possible to manage the products of the Netatmo Security range (outdoor and indoor cameras, door and window sensors, indoor siren, smoke detector). This allows you to quickly and easily create a Smart security system. The indoor unit can be PoE (power over Ethernet) powered, or directly powered using power supply 375005. Wall mounted using the supplied bracket.</p>

## STANDARD INDOOR UNITS - CATALOGUE



373005



373006



373007

Item	VIDEO INDOOR UNIT
<b>373005</b>	<p><b>7" touch display standard indoor unit, black finishing.</b></p> <p>From the touch display, it is possible to answer the call, open the lock, call the other apartments and the guard station, view call and alarm logs, leave audio messages, receive messages from the guard station, adjust the settings (e.g. brightness and ringtone) and view date/time information. Alarm management can be easily integrated thanks to 8 pre-arranged dedicated contacts. The integration with the Onvif IP cameras allows to view the IP cameras of the apartment and the common areas from the indoor unit. The specific integration also allows control of the lift. It is possible to associate the video indoor unit to the Home + Security App (available for Android and iOS). The App allows to use functions such as: receiving calls, door lock release, display of the event timeline and activation of the entrance panel. With the Home + Security App, it is also possible to manage the products of the Netatmo Security range (outdoor and indoor cameras, door and window sensors, indoor siren, smoke detector). This allows you to quickly and easily create a Smart security system. The indoor unit can be PoE (power over Ethernet) powered, or directly powered using power supply 375005. Wall mounted using the supplied bracket.</p>
<b>373006</b>	<p><b>7" touch display standard indoor unit, champagne gold finishing.</b></p> <p>From the touch display, it is possible to answer the call, open the lock, call the other apartments and the guard station, view call and alarm logs, leave audio messages, receive messages from the guard station, adjust the settings (e.g. brightness and ringtone) and view date/time information. Alarm management can be easily integrated thanks to 8 pre-arranged dedicated contacts. The integration with the Onvif IP cameras allows to view the IP cameras of the apartment and the common areas from the indoor unit. The specific integration also allows control of the lift. It is possible to associate the video indoor unit to the Home + Security App (available for Android and iOS). The App allows to use functions such as: receiving calls, door lock release, display of the event timeline and activation of the entrance panel. With the Home + Security App, it is also possible to manage the products of the Netatmo Security range (outdoor and indoor cameras, door and window sensors, indoor siren, smoke detector). This allows you to quickly and easily create a Smart security system. The indoor unit can be PoE (power over Ethernet) powered, or directly powered using power supply 375005. Wall mounted using the supplied bracket.</p>

Item	VIDEO INDOOR UNIT
<b>373007</b>	<p><b>7" touch display standard indoor unit, mirror finishing.</b></p> <p>From the touch display, it is possible to answer the call, open the lock, call the other apartments and the guard station, view call and alarm logs, leave audio messages, receive messages from the guard station, adjust the settings (e.g. brightness and ringtone) and view date/time information. Alarm management can be easily integrated thanks to 8 pre-arranged dedicated contacts. The integration with the Onvif IP cameras allows to view the IP cameras of the apartment and the common areas from the indoor unit. The specific integration also allows control of the lift. It is possible to associate the video indoor unit to the Home + Security App (available for Android and iOS). The App allows to use functions such as: receiving calls, door lock release, display of the event timeline and activation of the entrance panel. With the Home + Security App, it is also possible to manage the products of the Netatmo Security range (outdoor and indoor cameras, door and window sensors, indoor siren, smoke detector). This allows you to quickly and easily create a Smart security system. The indoor unit can be PoE (power over Ethernet) powered, or directly powered using power supply 375005. Wall mounted using the supplied bracket.</p>

# IP SYSTEM

## GUARD STATION AND ACCESSORIES - CATALOGUE



375000



375001



348200



348201



348202



348203



348204



348205



348206

Item

### GUARD STATION

**375000**

**Guard station with 10" touch display and handset.**  
From the touch display, it is possible to: answer and transfer calls, view call logs, release the locks, monitor IP cameras installed in common areas, monitor and process alarms. From the setting menu, it is possible to adjust the guard station settings, like volume and display brightness, and carry out functionality and network tests. Quick and scheduled absence can be activated to transfer the call to another guard station or to apartments if needed. The guard station can be PoE (power over Ethernet) powered, or directly powered using power supply 375005.



### ACCESSORIES

**375001**

**Server DES (Door Entry System) including configuration and management software** must be installed in the building under the VLAN network of the IP door entry system. The configuration software must be used to create, configure and update the entire installation. The software can be used to create the topology; entrance panels, guard station and indoor units are associated to the corresponding position in an easy and quick way using a scan tool. It also allows the programming of access control tools such as: RFID badges, card, fingerprint and face recognition. The software is also used to: program access control for new residents, view alarm logs, send messages to indoor units, upload advertisements and screensavers and synchronize time/date details on all devices.

**375003**

**Reader for programming card and badges for building access control.** Compatible with RFID badges 348200 to ..06 available in different colors. Programming and associating badges to residents requires the use of the configuration software.

**375004**

**Reader for programming fingerprints for building access control.** Registering and associating the residents' fingerprints requires the use of the configuration software.



### TRANSPONDER BADGE KEYS

Pack

<b>348200</b>	● Black	10
<b>348201</b>	● Red	10
<b>348202</b>	● Green	10
<b>348203</b>	● Blue	10
<b>348204</b>	● Orange	10
<b>348205</b>	● Grey	10
<b>348206</b>	● Yellow	10

## ACCESSORIES - CATALOGUE



Item	ACCESSORIES
<b>375002</b>	<b>PoE (Power over Ethernet) switch</b> with 10 / 100 Mbps, 8 PoE ports and 1 non-POE port uplink and 24 V-100 W power supply. The PoE port is used for network communication and as power supply. DIN mounted installation (Total of 14 DIN modules).
<b>375005</b>	<b>Power supply 100 W</b> with metal box; can operate as an auxiliary power supply. Protected against short circuits: in case of DC output short circuit, the device will switch to protected mode. Wall mounted installation.
<b>375006</b>	<b>(B) Metal box for video entrance panel</b> with 4.3" display and keypad, flush mounted installation. Compatible with Cat.No: - 374001 video entrance panel with 4.3" display and keypad, with face recognition and fingerprint - 374003 video entrance panel with 4.3" display and keypad
<b>375007</b>	<b>(A) Metal box for video entrance panel</b> with 10" touch display, flush mounted installation. Compatible with Cat.No: - 374000 video entrance panel with 10" touch display with face recognition and fingerprint - 374002 video entrance panel with 10" touch display
<b>375008</b>	<b>(C) Metal box for small video entrance panel</b> flush mounted installation. Compatible with Cat.No: 374004
<b>375009</b>	<b>(D) Metal box for small video entrance panel</b> with 4.3" vertical touch display, flush mounted installation. Compatible with Cat.No: 374005
<b>375010</b>	<b>Lift control interface with protocol translator</b> to integrate lift function in IP door entry system. The configuration is completed using a dedicate software, the interface is connected via RS 485 cable to the entrance panel and the lift.
<b>375011</b>	<b>USB key to be inserted on DES Server 375001</b> to enable face registration and to provide access mode for face recognition in the installation. At least one of the following devices must be present in the installation: external pushbutton panel with 10" touch display with face recognition and fingerprint (374000), external pushbutton panel with keyboard, facial recognition and fingerprint (374001) or Small pushbutton panel with 4.3 "touch display (374005).



(A) - (B) - (C) - (D) - Correspondence with the related entrance panels  
- see entrance panels page.

## DIMENSIONAL DATA

### Entrance panels

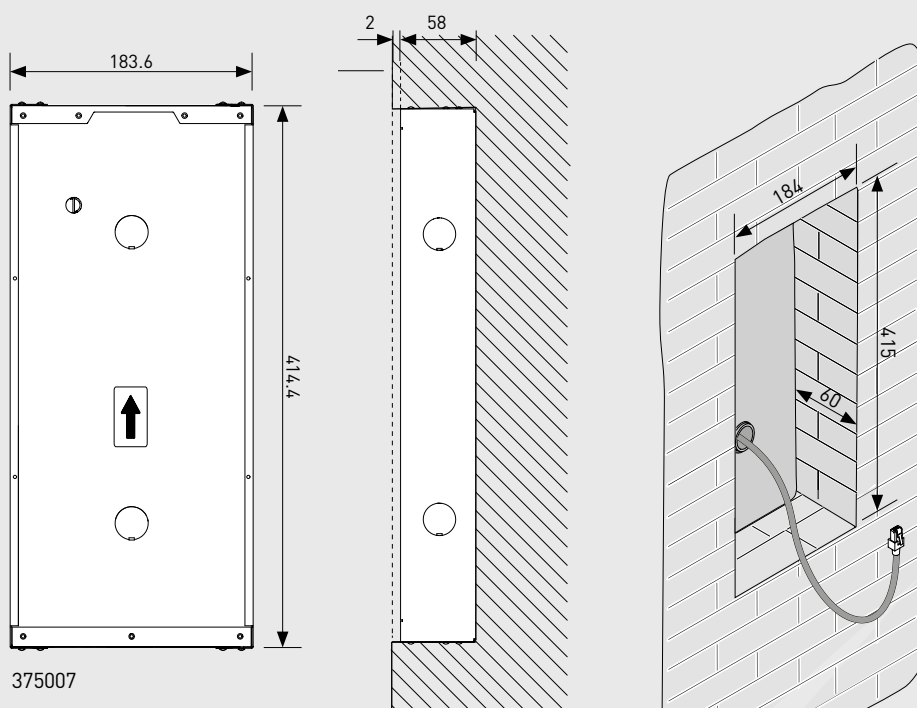
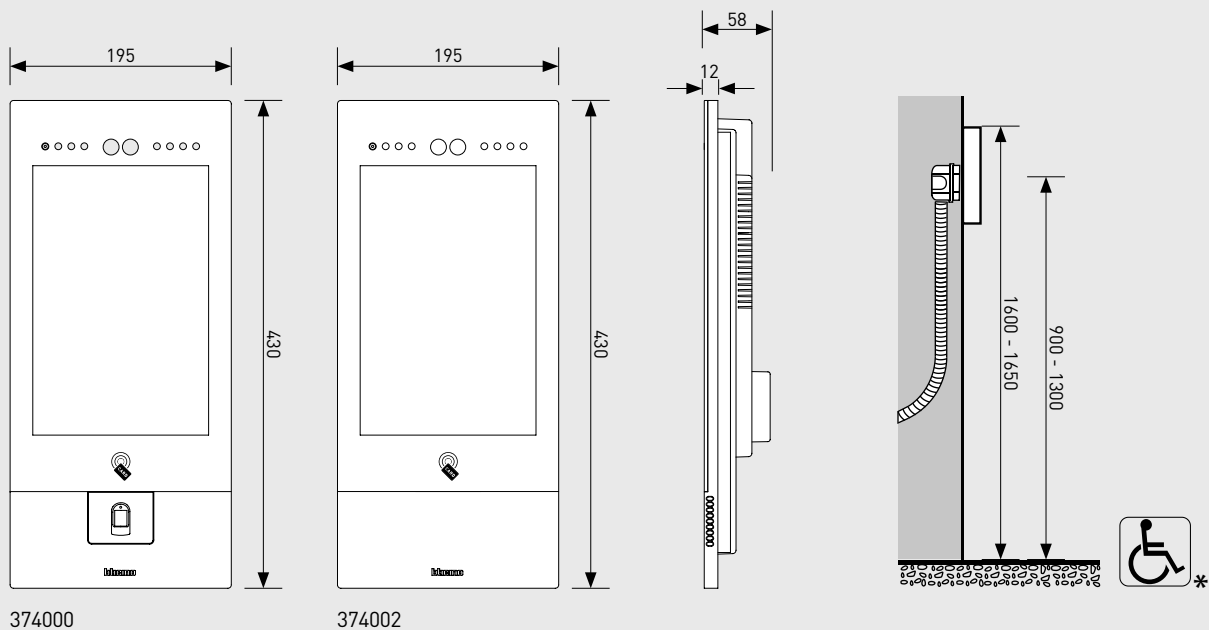

Dimensions expressed in millimeters

\*Recommended installation height



**DIMENSIONAL DATA**

**Entrance panels**

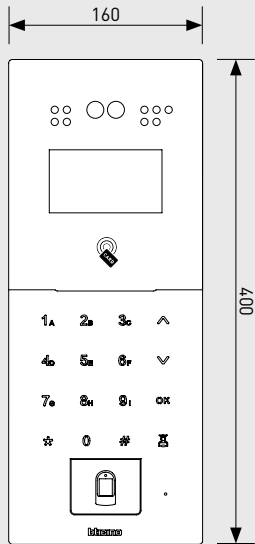

374001

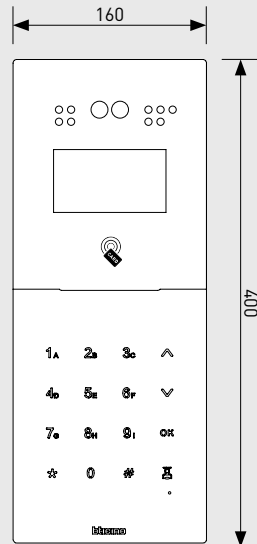

374003

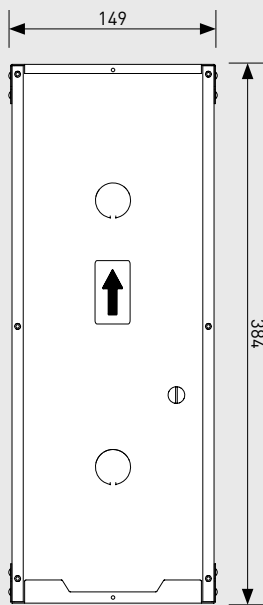
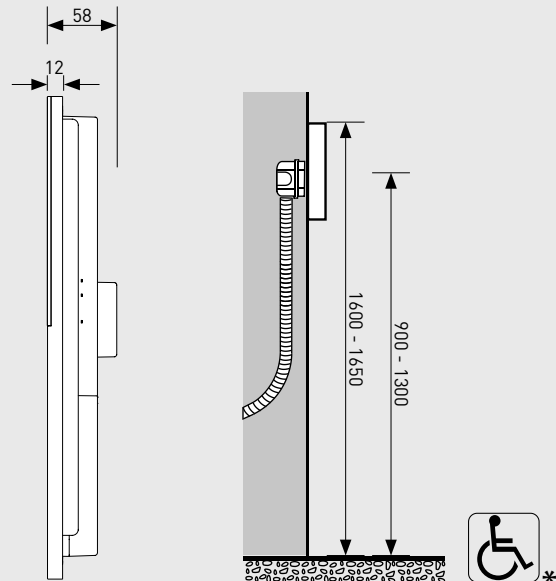

375006

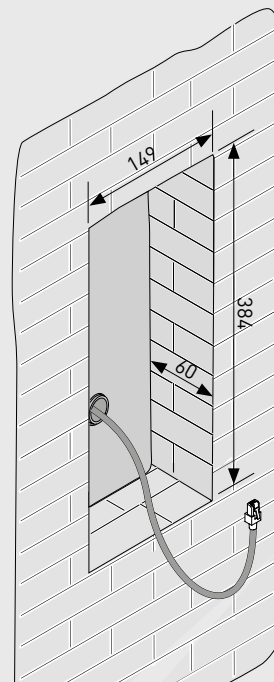
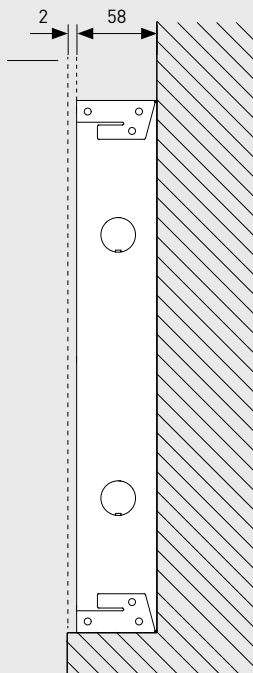

Dimensions expressed in millimeters

\*Recommended installation height

## DIMENSIONAL DATA

### Small entrance panel

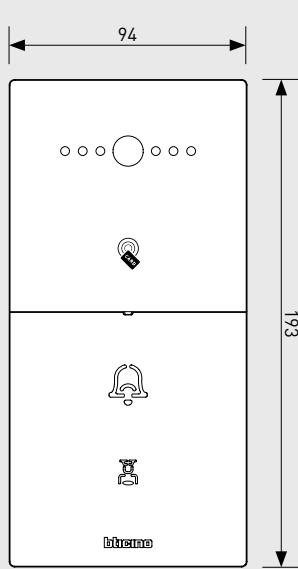

374004

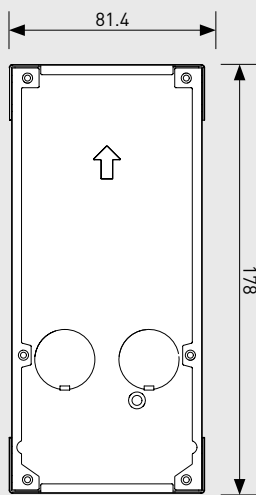
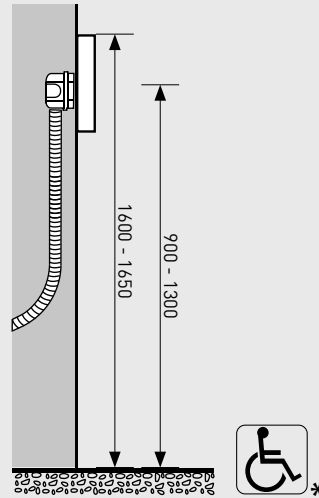
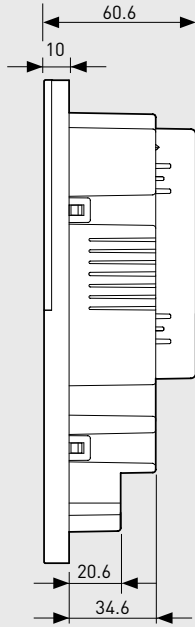

375008

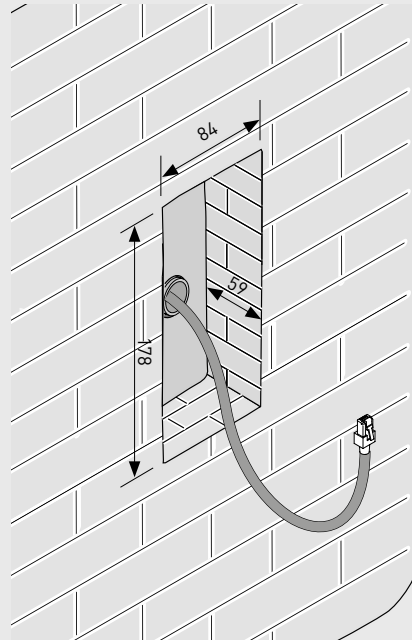
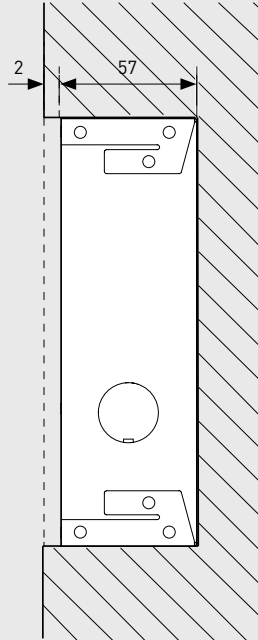

Dimensions expressed in millimeters

\*Recommended installation height

DIMENSIONAL DATA

Small entrance panel

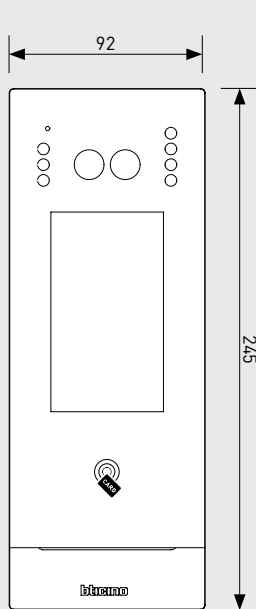

374005

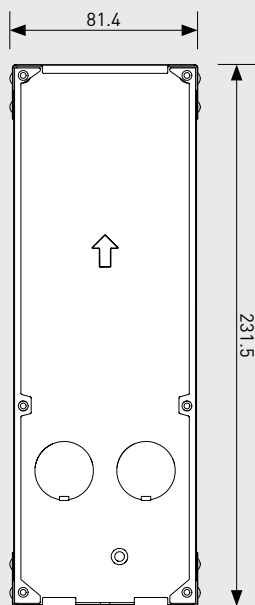
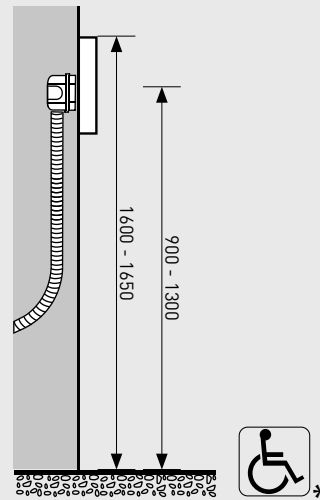
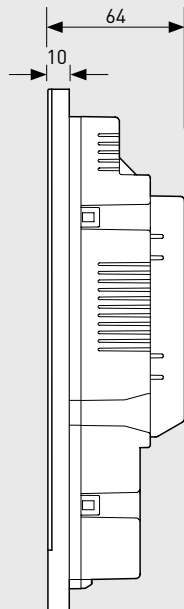

375009

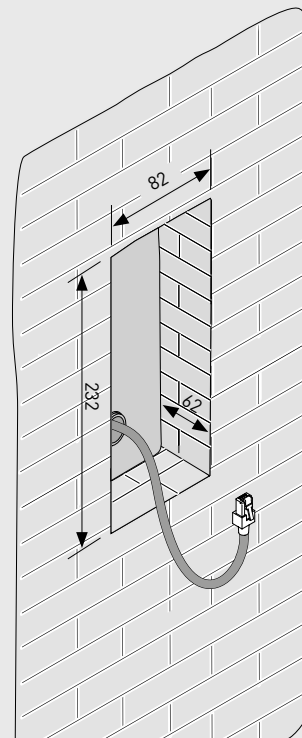
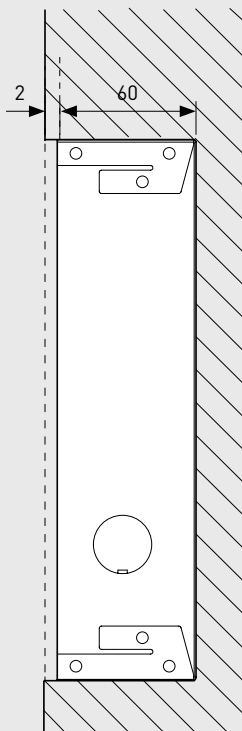

Dimensions expressed in millimeters

\*Recommended installation height

# IP SYSTEM

## DIMENSIONAL DATA

### Indoor units

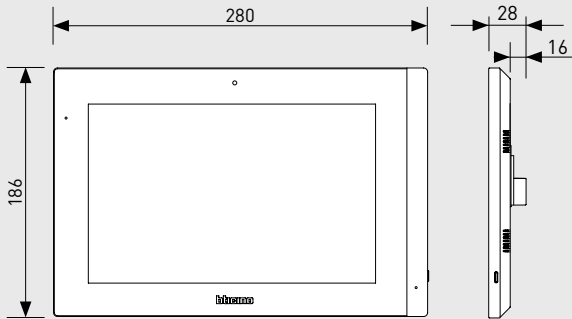

373001 - 373003

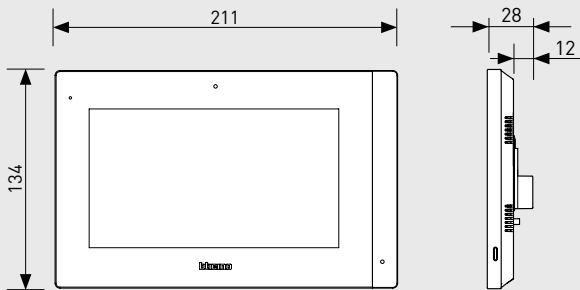
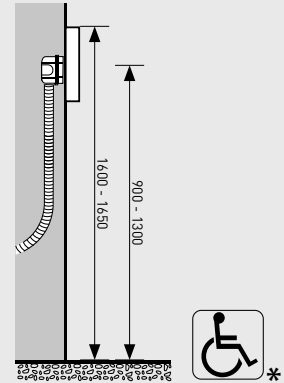
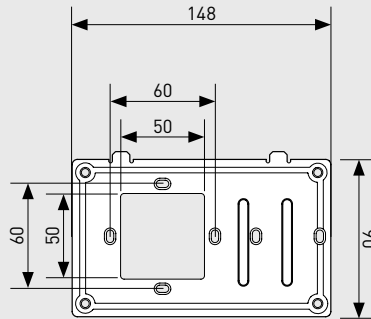

373002 - 373004

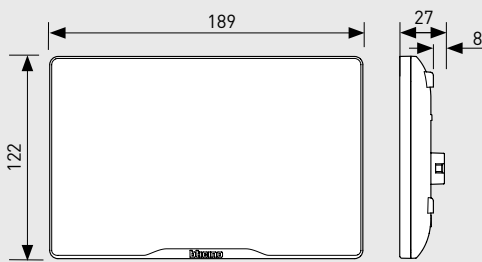
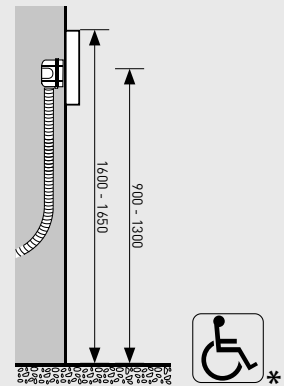
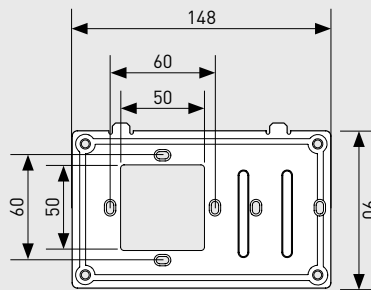

373005 - 373006 - 373007

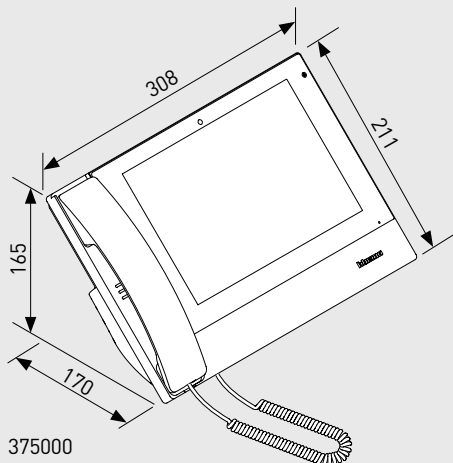
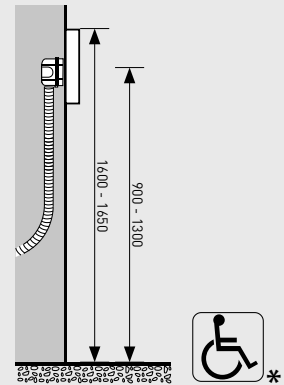
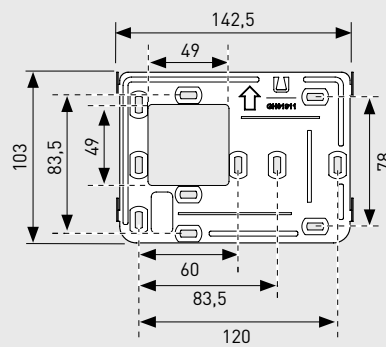

375000

Dimensions expressed in millimeters  
\*Recommended installation height

**DIMENSIONAL DATA**

**Accessories**

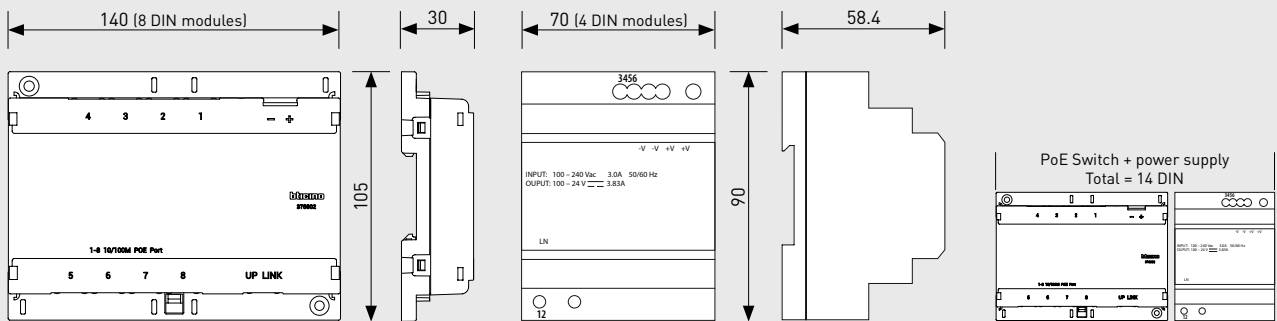

375002

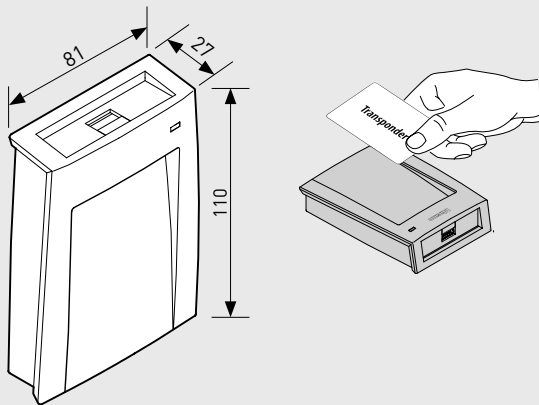

375003

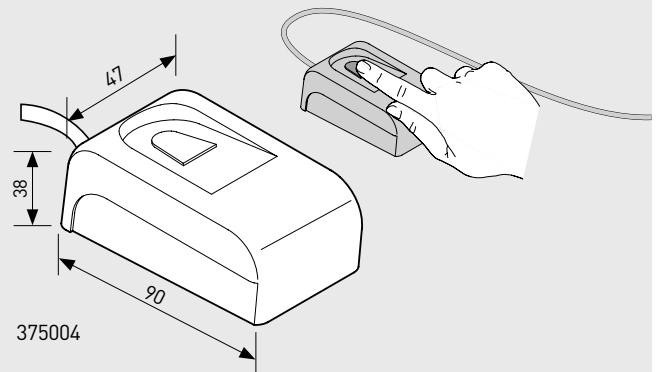

375004

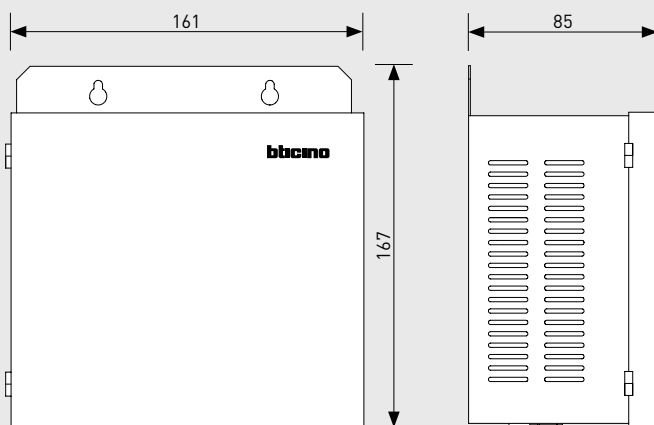

375005

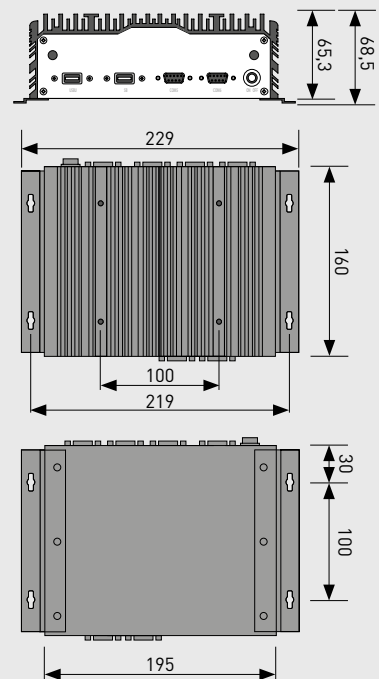

375001

Dimensions expressed in millimeters



# IP SYSTEM

## EXAMPLE - SYSTEM ARCHITECTURE

LAN Ethernet

LAN PoE BTicino

LAN PoE Standard

Apartment X  
Building 1

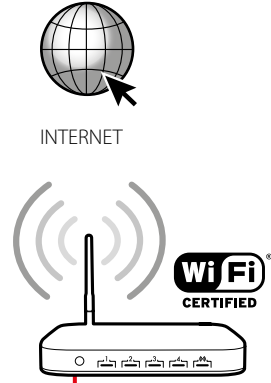
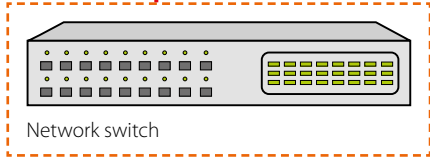
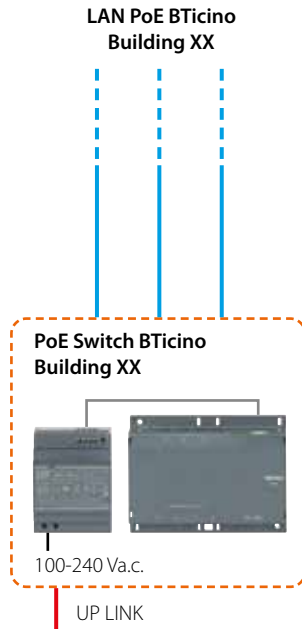
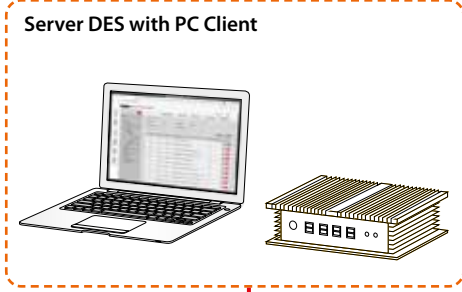
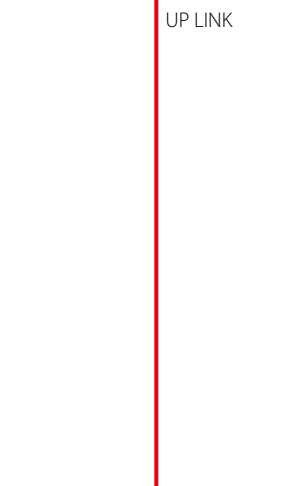
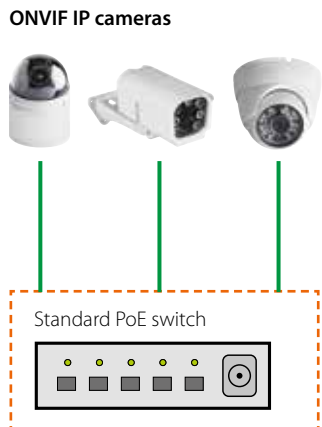
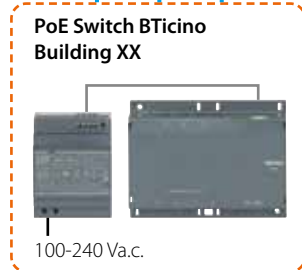
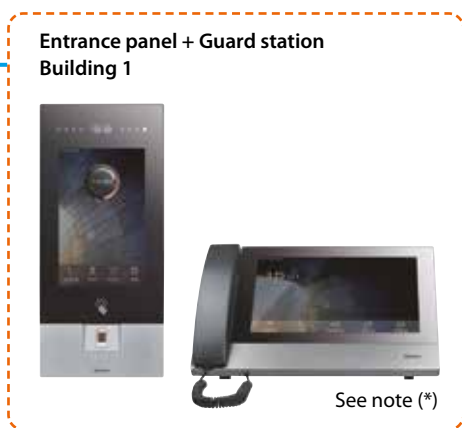

note (\*): provide a PoE LAN cable for each BTicino device.

## EXAMPLE – FIBER OPTIC RISER CONNECTION

Fiber optic

LAN Ethernet

LAN PoE BTicino

2 x Copper cables

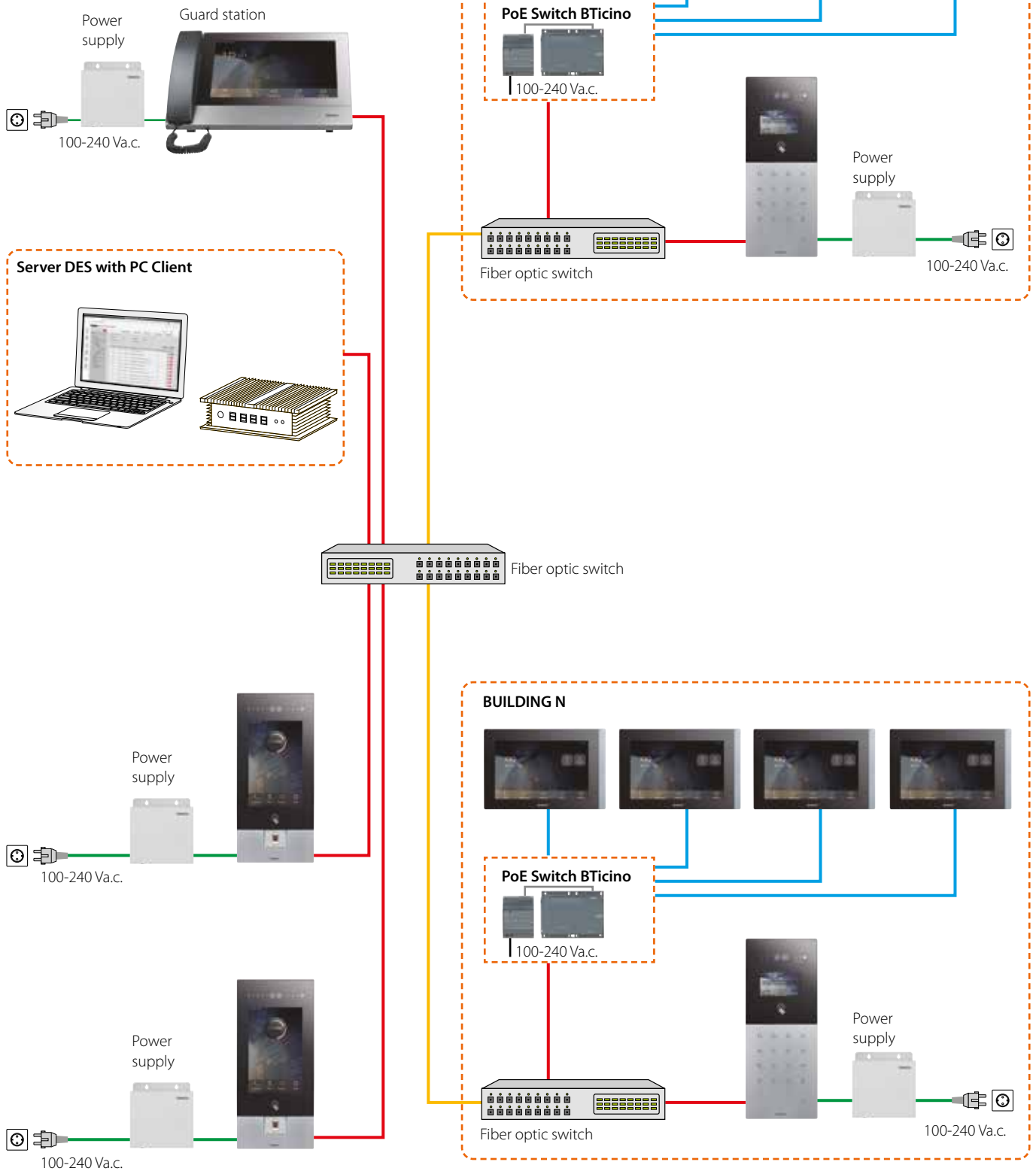

# IP SYSTEM

## EXAMPLE – INTERCOM FUNCTION

### INTERCOM FUNCTIONS

- audio intercom between indoor units:
  - of different apartments (same building or different buildings)
  - inside the same apartment

LAN Ethernet

LAN PoE BTicino

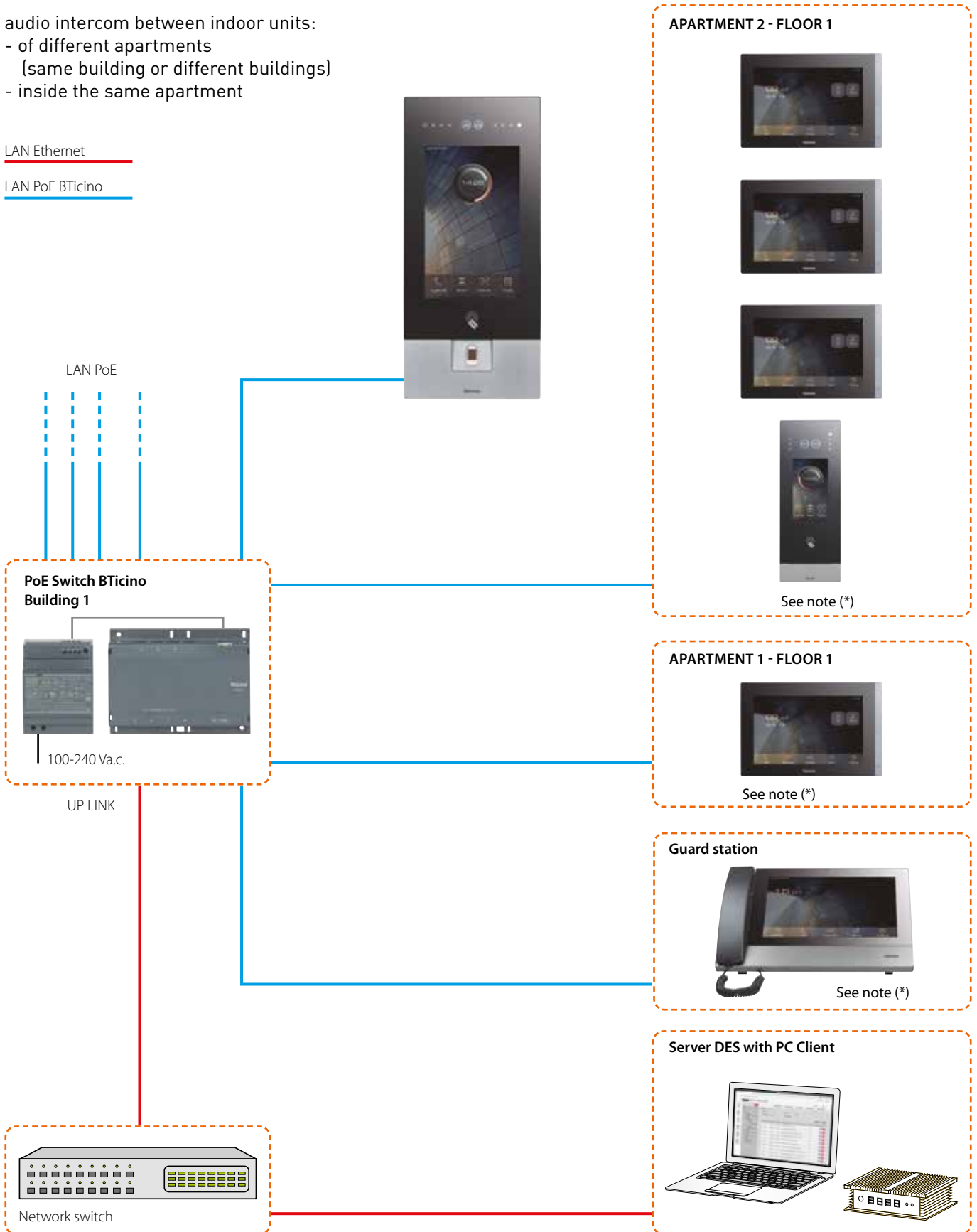

note (\*): provide a PoE LAN cable for each BTicino device.

## EXAMPLE - ALARMS INTEGRATION

### ALARM FUNCTIONS

The guard station receives all the alarm notification messages, including the SOS alerts coming from the indoor units.

LAN Ethernet

LAN PoE BTicino

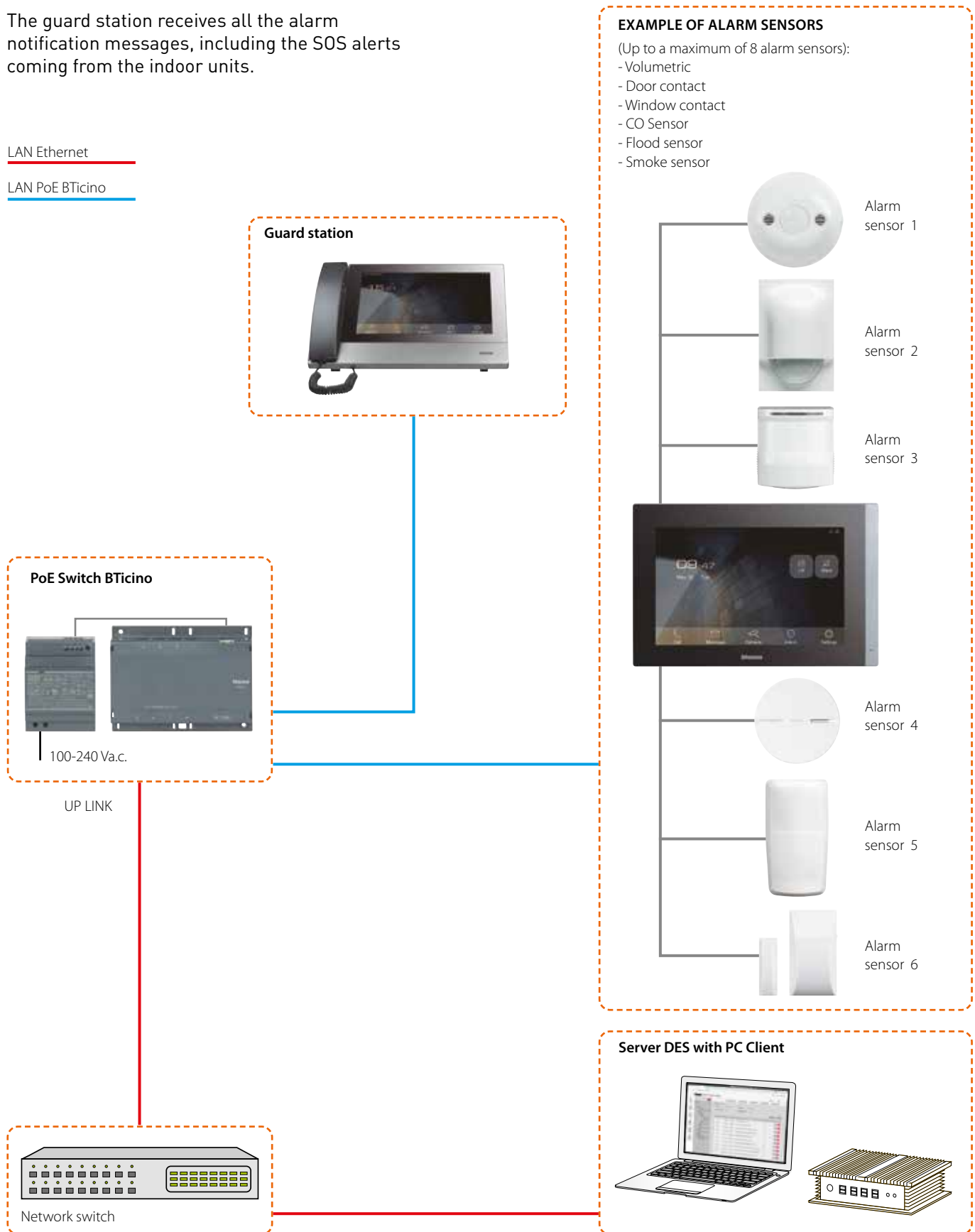

# IP SYSTEM

## EXAMPLE – IP CAMERA INTEGRATION

**Professional ONVIF IP camera models from different manufacturers can be selected using the IP Software**

- LAN Ethernet
- LAN PoE BTicino
- LAN PoE Standard

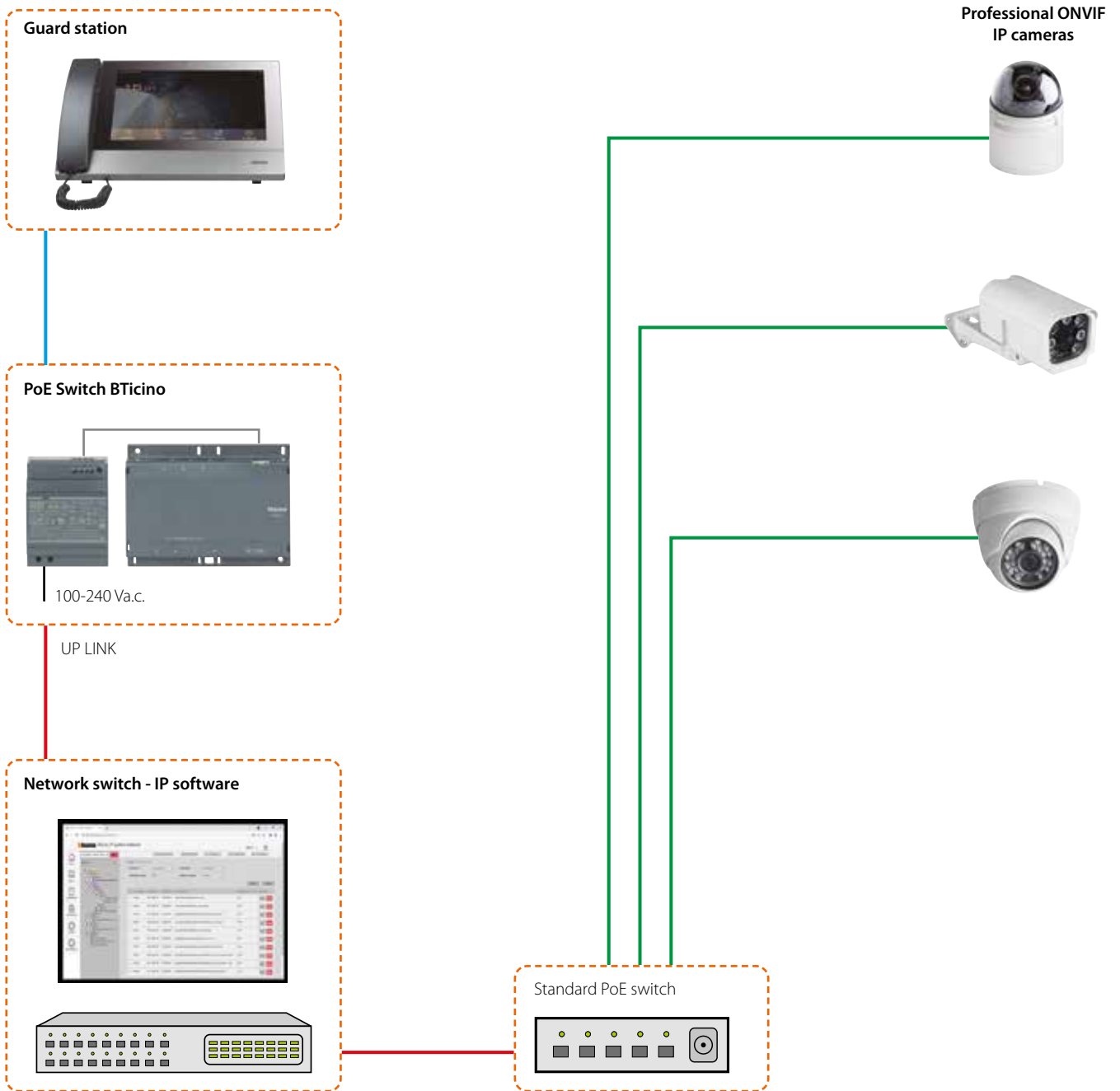



## EXAMPLE – LIFT CONTROL INTEGRATION

### Lift control integration can be performed in 2 different ways

#### ENTRANCE PANEL THIRD PARTY LIFT CONTROL DEVICE

BTicino only provides the lift control protocol for communicating the floor number based on the called apartment. The installer must provide the elevator controller and translate the protocol into a specific command for relays.

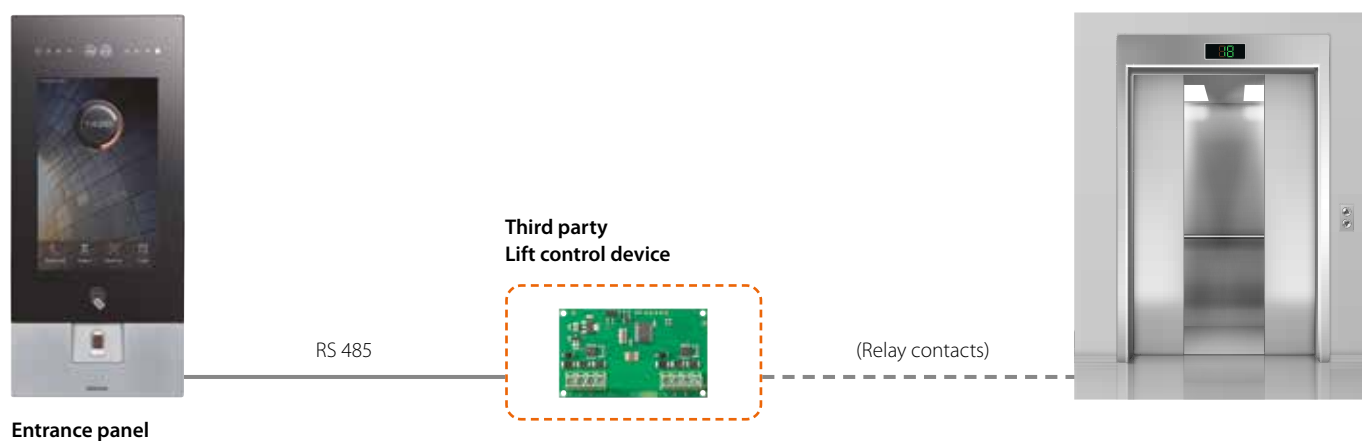

#### BTICINO (375010) LIFT CONTROL INTERFACE WITH PROTOCOL TRANSLATOR

The lift control interface must be configured using the dedicated software and selecting the lift brand and model. The entrance panel generates the information relating to which apartment has been called, the interface translates it according to the lift brand and model protocol and sends the information to the lift.

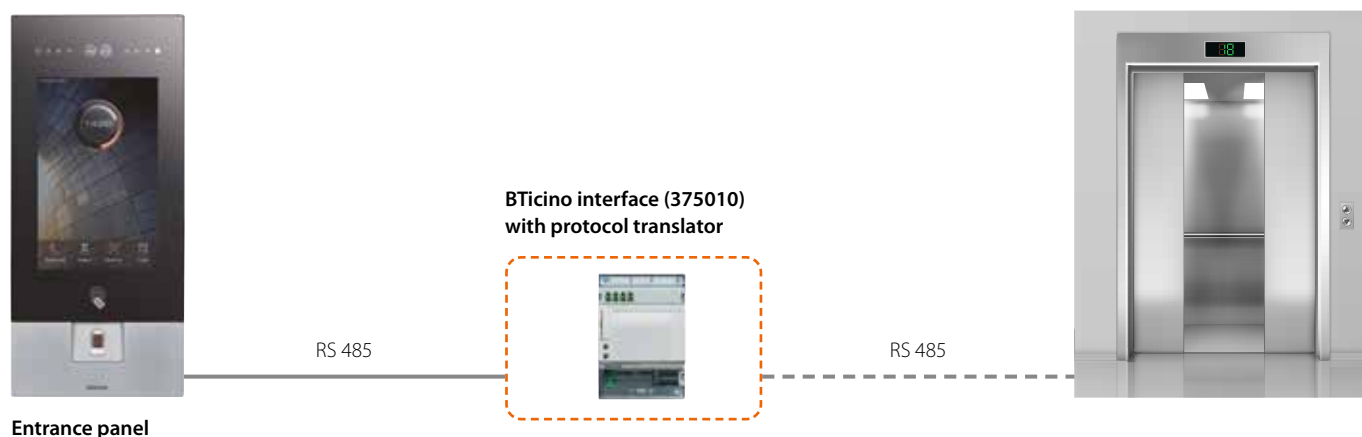

# NOTE

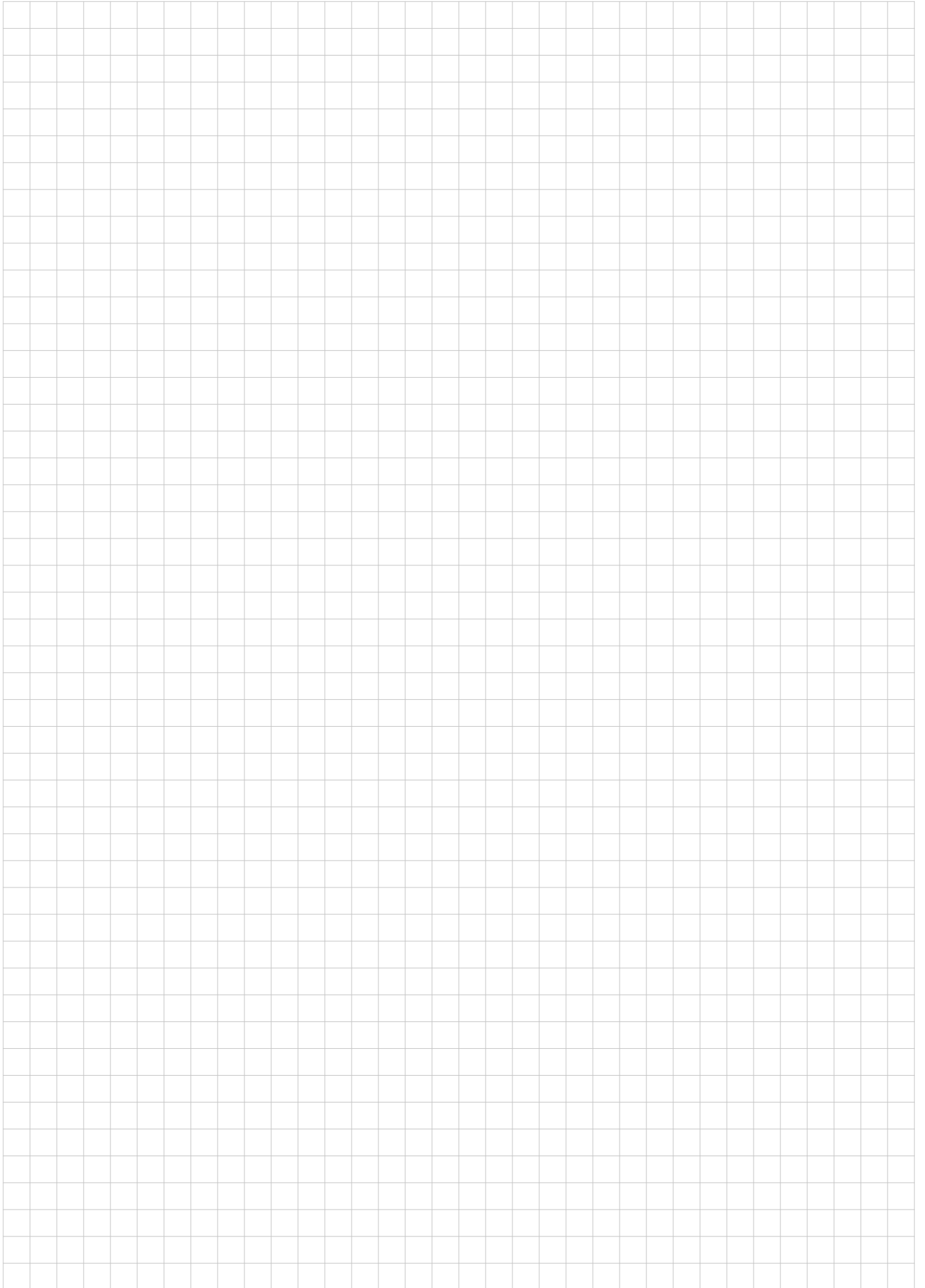



**BTicino** SpA  
Viale Borri, 231  
21100 Varese - Italy  
www.bticino.com